

LED Full Cutoff Wall Pack



LEDGEEKS
SMARTER SUPPLY AND SERVICE

Project Information _____

Type _____

Name _____

Voltage _____

Product Description

LEDGeeks Full Cutoff Wall Pack is designed By the most powerful and efficient heat sink, Die-casting Aluminum Alloy housing, Anti-Corrosion Painting, the completed LED light can work up to 50,000hours, Replacing traditional MH / HPS fixtures 120w-600w. saving up to 80% energy.



Applications

Entrance lighting, Courtyard lighting, Industrial lighting, Outdoor landscape lighting, Building lighting, etc.

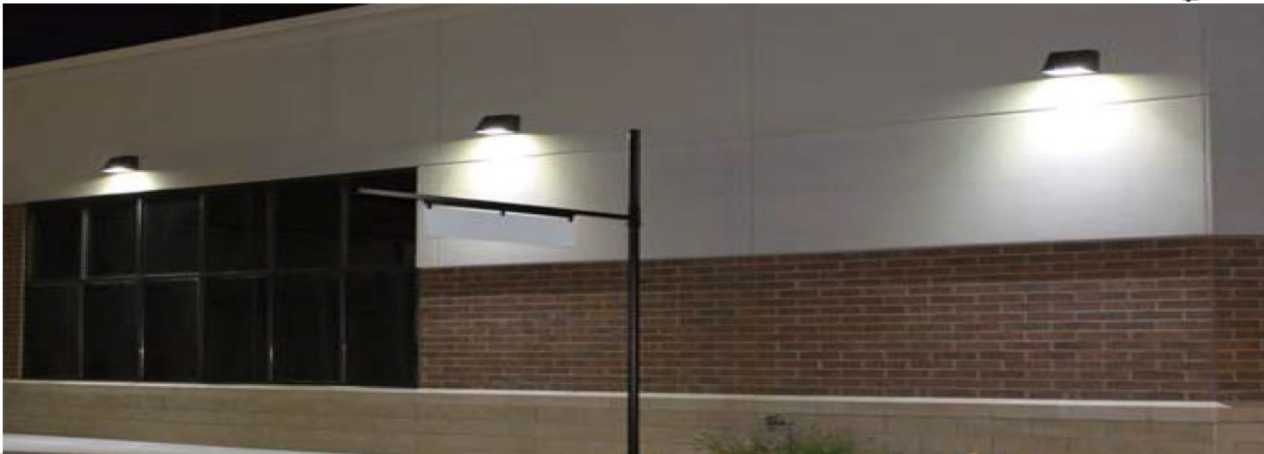

Electric Characteristic

Specification/Model	LS-FWP40W	LS-FWP60W	LS-FWP80W	LS-FWP100W	LS-FWP120W	LS-FWP150W
LED Chips	SMD 3030	SMD 3030	SMD 3030	SMD 3030	SMD 3030	SMD 3030
Input power	40W	60W	80W	100W	120W	150W
Lumens output	4600-5200LM	6900-7800LM	9200-10000LM	12000-13500LM	14000-16000LM	18000-20000LM
Efficiency	115-130M/W	115-130LM/W	115-130LM/W	120-135LM/W	120-135LM/W	120-135LM/W
Housing	Die-Casting Aluminum Alloy housing, Anti-Corrosion Painting					
Finish	Brown, Black, White					
Input voltage	100-277V / 200-480V					
Dimension	L 14.1 * W 9.2* H 9.6 in					
Beam Angle	155°95°					
Photocell	Available					
Mounting	Wall Mount					
Lamps Efficiency	≥90%					
Certificate	UL DLC					
Equivalent	120-180W MH/HPS	180-240W MH/HPS	240-300W MH/HPS	300-360W MH/HPS	360-400W MH/HPS	400-600W MH/HPS

Ordering Information

Example: LS-FWP40W-50K-N-B

Product	Power	Replacement	Color Temperature	Photocell	Furnish
LS-FWP40W	40W	120-180W MH/HPS	40K=4000K 45K=4500K 50K=5000K 57K=5700K	N not photocell Y yes photocell	B-Brown
LS-FWP60W	60W	180-240W MH/HPS			
LS-FWP80W	80W	240-300W MH/HPS			
LS-FWP100W	100W	300-360W MH/HPS			
LS-FWP120W	120W	360-400W MH/HPS			
LS-FWP150W	150W	400-450W MH/HPS			

Photometrics

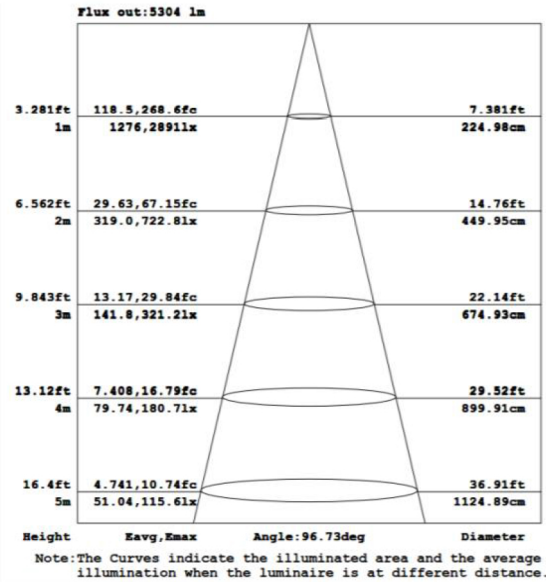
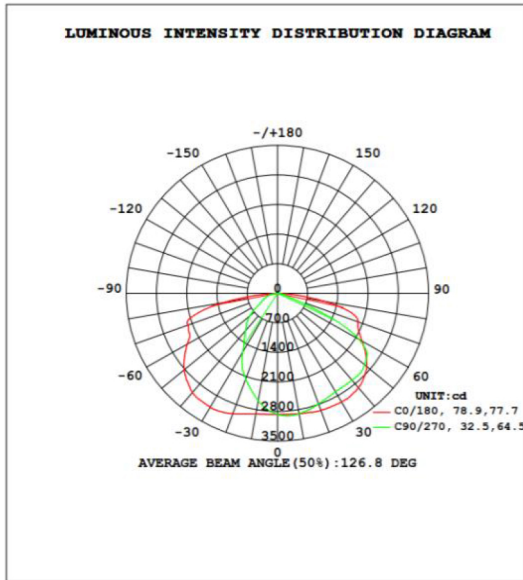

Projected LED Lumen Maintenance

Operating hours	0	25000	50000
Lumen maintenance factor	1	0.91	0.8

Data references the extrapolated performance projections for the LED Full Cutoff wall Pack Light platform in a 25°C ambient, based on 10,000 hours of LED testing (tested per IESNA LM-80-08 and projected per IESNA TM-21-11).

Dimensions

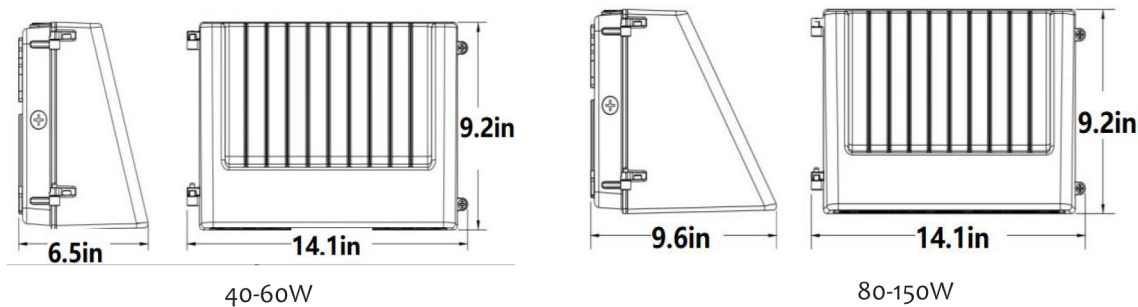

After-Sale Service

The product refers to electricians knowledge. Please don't disassemble it by yourself. If any quality problem happens, please contact the factory for warranty details.

NOTE: Actual performance may differ as a result of end-user environment and application. All values are without notice.

The installation of the product can be used when it is marked with "✓".

☑ Installation I :

1. Take out the light, and loosen the screws on the cover and take apart the fixture by the screwdriver. Pull off the quick connect terminal vigorously. (Fig. 1-1A&B)



Fig. 1-1A

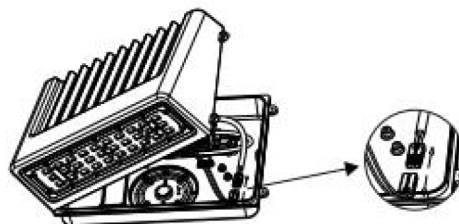

Fig. 1-1B

2. Drill an installation holes at the bottom of light, paste the EVA mat. (Fig. 1-2A&B)

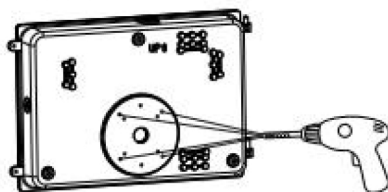

Fig. 1-2A

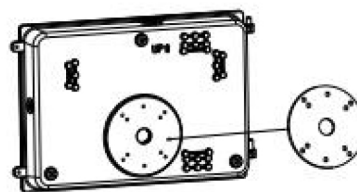

Fig. 1-2B

-1-

3. Loosen the plug on the bottom plate, then put the wiring through the hole, screw the bottom cover with junction box on the wall.(Fig. 1-3A&B)

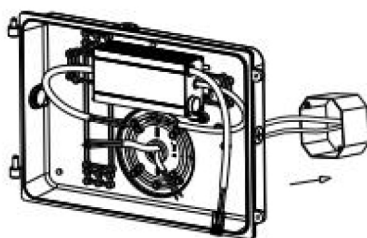

Fig. 1-3A

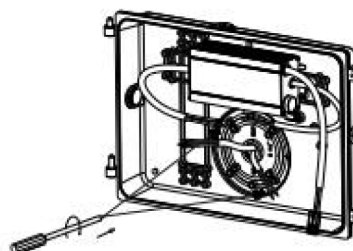

Fig. 1-3B

4. Make wiring connections per "Electrical Connections" section and make sure the good wire protection.(Fig. 1-4)

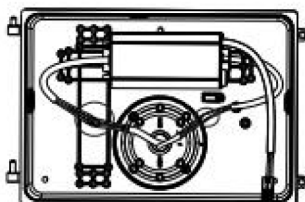

Fig. 1-4

L/live wire: Black\Brown;
 N/null wire: White\Blue;
 Ground wire: Green\Yellow-green;
 DIM+: Purple;
 DIM-: Gray.

5. Connect the quick connect terminal, then screw the fixture with bottom plate. (Fig. 1-5A&B)

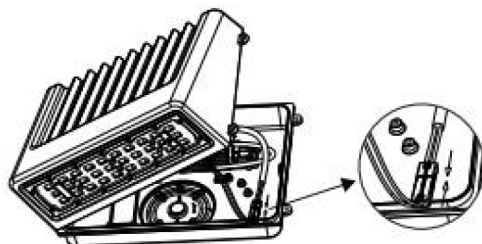

Fig. 1-5A



Fig. 1-5B